

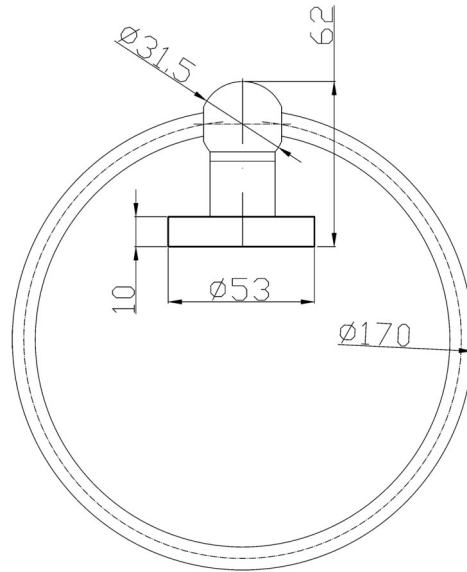

الركن الأوروبي
ش.ذ.م.م.
EUROPEAN CORNER L.L.C

Al Wadi Building, Sheikh Zayed Road
P. O. Box 31840, Dubai
United Arab Emirates
Showroom Tel: +971 4 3356315
Office Tel: +971 4 3360601
Fax: +971 4 3360604
E-mail: gm@europeancorner-dubai.com

SPECIFICATION SHEET



Manufacturer	MEDICLINICS-SPAIN
Model	MEDICROM
Description	TOWEL RING 170 MM
Finish	CHROME BRASS
Article Code	AC0979C